

## Application

The FD180 fire damper employs airfoil blades for point-of-origin control of fire in static and dynamic HVAC systems. The FD180 is qualified to 3,000 ft/min (15.3 m/s) and 4 in.wg. (1.0 kPa) and may be installed in vertical walls or partitions, or horizontally in floors or assemblies with fire resistance ratings up to 2 hours.

## Standard Construction

**Frame:** 5" × 1" (127 × 25) galvanized steel hat channel with interlocking corner gusset. Equivalent to 13 gauge (2.4) channel frame. Low profile head and sill are used on sizes less than 13" (330) high.

**Blades:** 6" × 14 gauge (152 × 2.0) equivalent galvanized steel airfoil.

**Axles:** ½" (13) diameter plated steel hex.

**Linkage:** Concealed in frame.

**Bearings:** Stainless steel oilite, sleeve-type.

**Seals:** Silicone blade edge seals integrally rolled and mechanically fastened to blades. Flexible metal jamb seals.

**Fire Closure Device:** Fusible link.

**Fire Closure Temperature:** 165°F (75°C).

**Minimum Size:** 6" × 6" (152 × 152)

**Maximum Size:** Single section: 32" × 48" (813 × 1219)  
Vertical mount: 144" × 96" (3658 × 2438) or  
60" × 150" (1524 × 3810)  
Horizontal mount: 144" × 96" (3658 × 2438)

## Options

- PI-50 — Dual position indicator switch package.
- Factory installed sleeve:
  - Gauge:  20 (1.0)  18 (1.3)  16 (1.6)
  - 14 (2.0)  10 (3.5)
  - Length:  12" (305)  16" (406)  24" (610)
  - Other \_\_\_\_\_
- Transitions (sleeve required):  Flanged
  - Round  Oval
  - Duct connections:  1" (25) S-clip  1½" (38) S-clip
  - DM25  DM35  S & Drive  WARD
- Retaining angle systems:
  - Gauge:  20 (1.0)  16 (1.6)
  - Picture frame:  SSPF (single-side)  DSPF (2-sided)
  - Individual angle sets:  SS (single-side)  DS (2-sided)
- Alternate fire closure temperature:
  - 212°F (100°C)
- Duct access door factory mounted in common sleeve.
- Generic mullion for oversized masonry or concrete openings.
- Manual locking quadrant.

## Ratings

**UL 555 Fire Resistance Rating:** 1½ hour (vertical and horizontal)

**Maximum Dynamic Closure Velocity:** 3,000 fpm (15.3 m/s)

**Maximum UL555S Rated Pressure:** 4 in.wg. (1.0 kPa)

## Listings

**UL 555 listing:** R14981

**CSFM listing:** 3225-1404:108

**Meets NFPA Standards:** 90A, 92A, 92B and 101

**Meets Building Code Standards:** IBC, NBC, NFPA, SBC and UBC

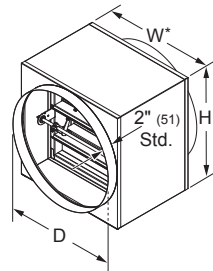

**Type R (optional)**  
Round duct transitions are standard with D=W=H. (available with D<W and H)

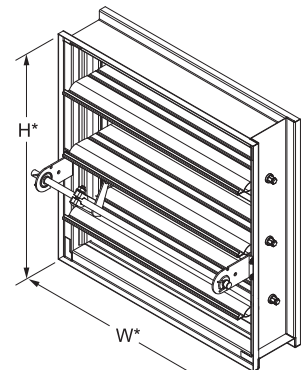

**Model FD180**  
(standard)

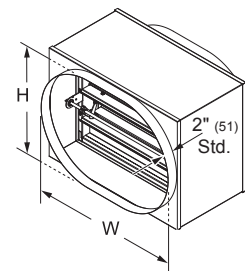

**Type O (optional)**  
Oval duct transitions are standard with W and H equal to damper width and height dimensions. (available with W and H smaller than damper width and height)

†Damper dimensions furnished approximately ¼" (6) undersize. (sleeve thickness not included)

# Typical Damper Dimensional Data

The drawings and corresponding table show the position of the damper when mounted in a factory sleeve. The standard mounting locations provide enough space for installation of retaining angles and duct connections.

Damper Height	J	X
<8"	2"	1-1/2"
≥8"	3-3/8"	1/8"

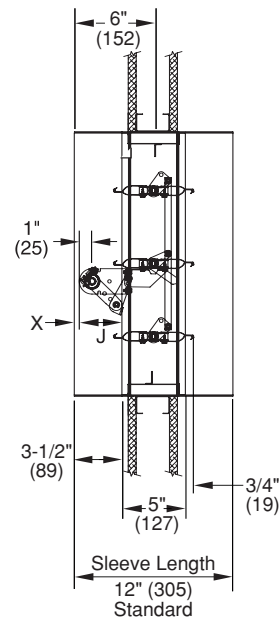
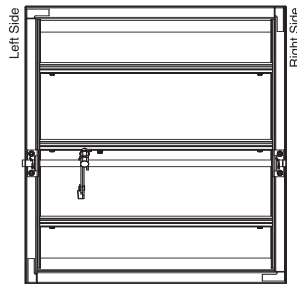

**NOTE:** 1. The entire damper frame is not required to be installed within the wall, partition or floor. However, the closed plane of the damper blades must be inside the wall, partition or floor.

# Airflow Performance Data

## Pressure Loss vs. Velocity

Figure 5.3 — Ducted Inlet and Outlet

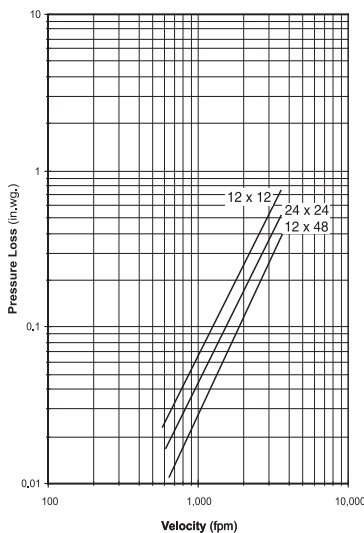

Figure 5.2 — Ducted Inlet

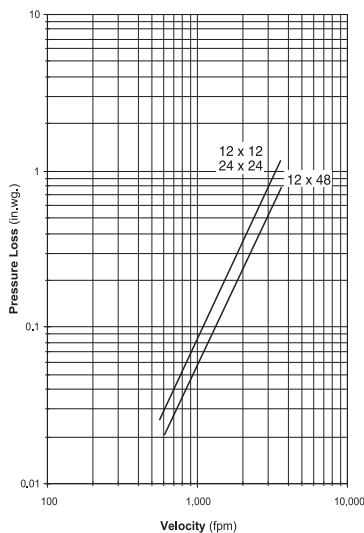
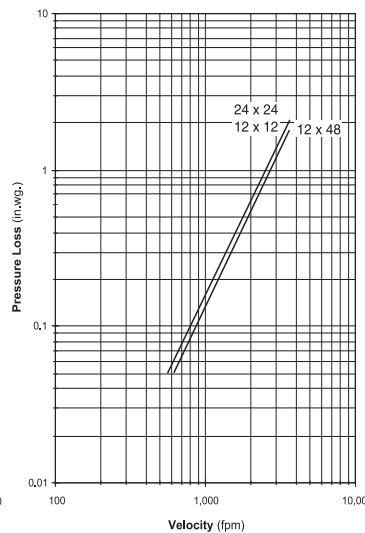

Figure 5.5 Plenum Mount



Pressure drop testing was performed in accordance with AMCA Standard 500-D using the three configurations shown. All data has been corrected to represent air density of 0.075 lb/ft. Actual pressure drop in any ducted HVAC system is a combination of many elements. This information, along with analysis of other system influences, should be used to estimate actual pressure losses for a damper installed in a given HVAC system.



### Ducted Inlet and Outlet

AMCA Figure 5.3 illustrates a fully ducted damper. This configuration represents the lowest pressure drop of the three test configurations because entrance and exit losses are minimized by straight duct runs upstream and downstream of the damper.

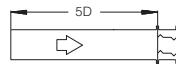

### Ducted Inlet

AMCA Figure 5.2 illustrates a ducted damper exhausting air into an open area. This configuration has a lower pressure drop than Figure 5.5 because entrance losses are minimized by a straight duct run upstream of the damper.



### Plenum Mount

AMCA Figure 5.5 illustrates a plenum mounted damper. This configuration has the highest pressure drop because of extremely high entrance and exit losses due to the sudden changes of area in the system.