

Application

The SBE-245 combination louver features stationary louver blades and an integral gravity operated backdraft damper to protect exhaust air openings in exterior walls. The SBE-245 is available in a wide array of painted finishes including custom color matching.

Standard Construction

Material: Galvanized.

Frame: 2" deep × 20 ga. thick (51 × 1) channel.

Blades: 45° × 20 ga. (1) thick J-style BD-exhaust.

Screen: 1/2" × 0.063" (12.7 × 1.6) expanded and flattened aluminum.

Mullion: Visible.

Minimum Size: 12" × 12" (305 × 305)

Maximum Size: Single section: 36" × 120" (914 × 3048)
Multiple section: Unlimited

Options

- Factory finish:
 - Polyester Powder
 - Baked Enamel
 - Prime Coat
- 1 1/2" (38) flange frame.
- Welded construction.
- Alternate bird or insect screens.
- Insulated or non-insulated blank-off panels.
- Filter racks.
- Hinged frame.
- Heavy duty 16 ga. (1.6) construction.
- 304 stainless steel construction.

Ratings

Free Area: [48" × 48" (1222 × 1222) unit]: 6.6 ft² (0.61 m²)
41.0%

Performance @ Beginning Point of Water Penetration

Free Area Velocity: 383 fpm (1.95 m/s)
Air Volume Delivered: 2,528 cfm (1.19 m³/s)
Pressure Loss: 0.08 in.wg. (20 Pa)

Design Load: 30 psf

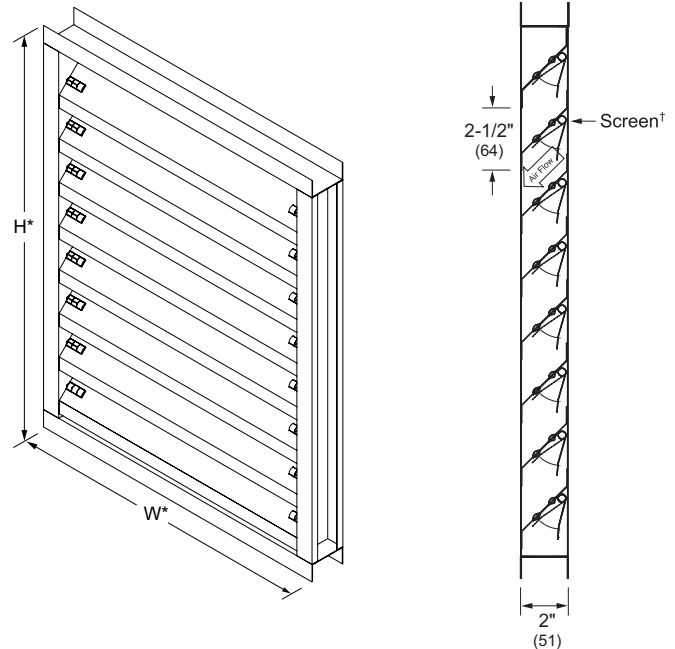

Model SE-245
(standard)

*Louvers dimensions furnished approximately 1/2" (13) undersize.

Vertical Section

†Screen adds approximately 3/16" (5) to louver depth.

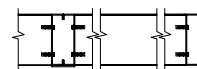

Vertical Mullion
(standard)

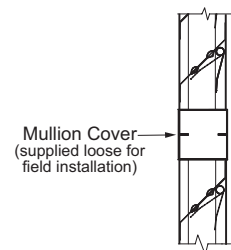

Horizontal Mullion
(standard)

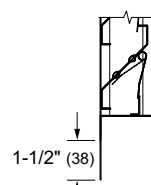

Flange Frame
(optional)

Performance Data

Figure 5.2 — Ducted Inlet

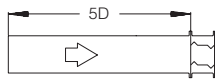
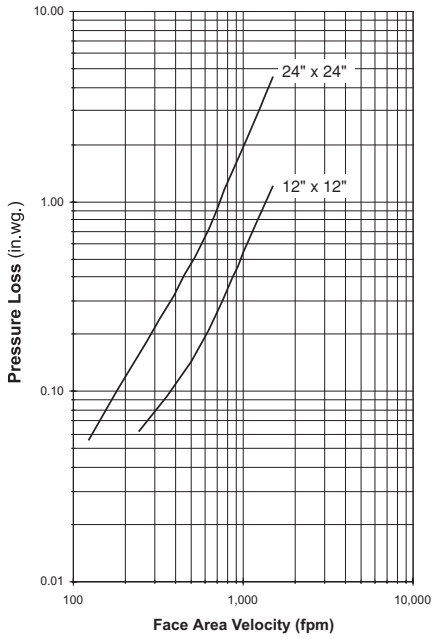

Ducted Inlet

AMCA Figure 5.2 illustrates a ducted damper exhausting air into an open area. This configuration has a lower pressure drop than Figure 5.5 because entrance losses are minimized by a straight duct run upstream of the damper.

Figure 5.5 — Plenum Mount

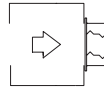
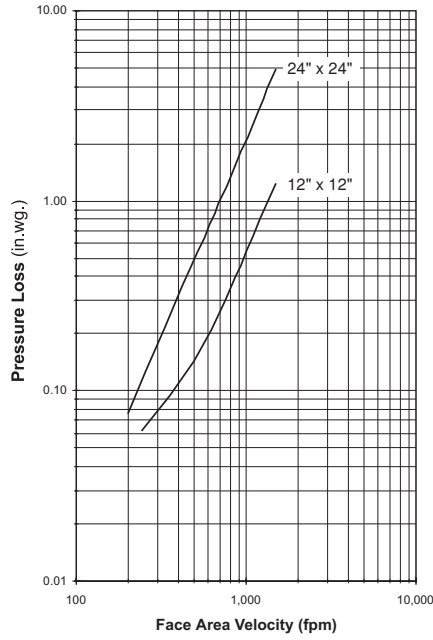

Plenum Mount

AMCA Figure 5.5 illustrates a plenum mounted damper. This configuration has the highest pressure drop because of extremely high entrance and exit losses due to the sudden changes of area in the system.

Pressure drop testing was performed in accordance with AMCA Standard 500-D using the three configurations shown. All data has been corrected to represent air density of 0.075 lb/ft. Actual pressure drop in any ducted HVAC system is a combination of many elements. This information, along with analysis of other system influences, should be used to estimate actual pressure losses for a damper installed in a given HVAC system.